

JVC



COMPACT DISC AUTOMATIC CHANGER

XL-FZ700BK

Introduction	2
Before using for the first time	5
Basic operations	7
Various playback patterns	11
General informations	13

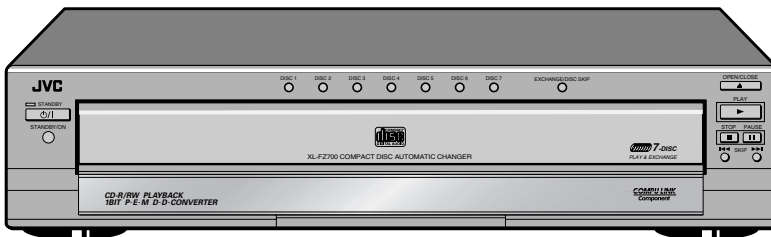

COMPACT
disc
DIGITAL AUDIO

COMPU LINK
Component

INSTRUCTIONS

For Customer Use:

Enter below the Model No. and Serial No. which are located on the rear, bottom or side of the cabinet. Retain this information for future reference.

Model No. _____

Serial No. _____

LVT0863-003A

[UJ]

Warnings, Cautions and Others

CAUTION

To reduce the risk of electrical shocks, fire, etc.:

1. Do not remove screws, covers or cabinet.
2. Do not expose this appliance to rain or moisture.

Caution — STANDBY/ON button!

Disconnect the mains plug to shut the power off completely. The  STANDBY/ON button in any position does not disconnect the mains line. The power can be remote controlled.

CAUTION

- Do not block the ventilation openings or holes.
(If the ventilation openings or holes are blocked by a newspaper or cloth, etc., the heat may not be able to get out.)
- Do not place any naked flame sources, such as lighted candles, on the apparatus.
- When discarding batteries, environmental problems must be considered and local rules or laws governing the disposal of these batteries must be followed strictly.
- Do not expose this apparatus to rain, moisture, dripping or splashing and that no objects filled with liquids, such as vases, shall be placed on the apparatus.

Caution: Proper Ventilation

To avoid risk of electric shock and fire and to protect from damage.

Locate the apparatus as follows:

- Front: No obstructions and open spacing.
Sides: No obstructions in 3 cm from the sides.
Top: No obstructions in 5 cm from the top.
Back: No obstructions in 15 cm from the back
Bottom: No obstructions, place on the level surface.

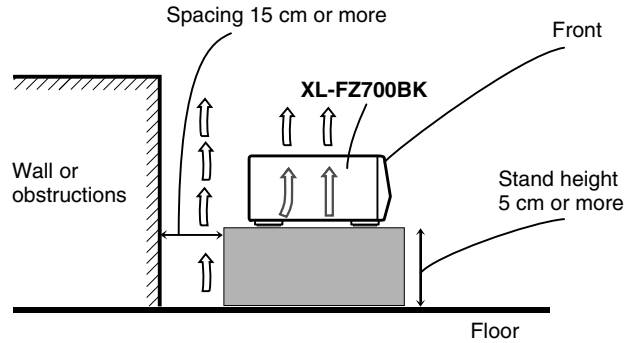

IMPORTANT FOR LASER PRODUCTS

REPRODUCTION OF LABELS

① CLASSIFICATION LABEL, PLACED ON REAR ENCLOSURE

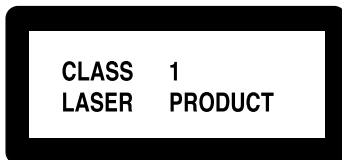

② WARNING LABEL, PLACED INSIDE THE UNIT

CAUTION: Invisible laser radiation when open and interlock failed or defeated. AVOID DIRECT EXPOSURE TO BEAM. (e)	WARNING: Osynlig laserstrålning när denna del är öppnad och spärren är urkopplad. Betrakta ej strålen. (s)	ADVARSEL: Usynlig laserstrålning ved åbning, når sikkerhedsafbrydere er ude af funktion. Undgå udsættelse for stråling (d)	VARO: Avattaessa ja suo- jalukitus ohitettaessa olet alltiina näkymättömälle lasersäteilylle. Älä katso säteeseen. (f)
--	---	---	---

1. CLASS 1 LASER PRODUCT
2. **CAUTION:** Visible and invisible laser radiation when open and interlock failed or defeated. Avoid direct exposure to beam.
3. **CAUTION:** Do not open the top cover. There are no user serviceable parts inside the Unit; leave all servicing to qualified service personnel.

We would like to thank you for purchasing one of our JVC products.
 Before connecting this unit to the wall outlet, please read the instructions carefully to ensure that you obtain the best possible performance.
 If you have any questions, please consult your JVC dealer.

Table of Contents

Introduction	Page 2
Precautions	2
About this manual	2
Names of buttons	3
Main unit.....	3
Remote control unit.....	4
Display window.....	4
Before using for the first time	Page 5
Installing the unit	5
Connecting to the Analog Output Jacks	5
Connecting to the Digital Output Jack	5
Supplying the power	5
To connect the AC power cord of the main unit.....	5
To install the batteries in the remote control unit.....	6
COMPU LINK connection	6
Basic operations	Page 7
Basic functions for disc playback	7
Turning on the power of this unit.....	7
Remote control operation.....	7
Inserting and removing discs.....	7
Playing a disc.....	8
Stopping playback.....	8
Locating a point to start playback	9
Skipping to a desired disc during playback (DISC SKIP).....	9
Changing to a desired disc during playback DISC (1-7).....	9
Skipping to a desired track during playback.....	9
Searching for a desired section.....	9
Specifying a desired track in stop mode.....	10
Changing discs during playback (EXCHANGE)	10
Playing tracks in a order of disc/track number	10
Various playback patterns	Page 11
Playing tracks in a desired order (Program Play)	11
Playing tracks in a random order (Random Play)	12
Playing repeatedly (Repeat Play)	12
Repeating all the tracks of a disc.....	12
Repeating one track.....	12
General informations	Page 13
COMPU LINK remote control system	13
Care and handling	14
Troubleshooting	15
Specifications	15

Precautions

Load compact discs only

Never insert anything other than compact discs into any part of the player.

If a problem persists

If something goes wrong, turn off the power immediately. If the same problem reoccurs when the power is turned on once more, turn off the power again and consult your JVC dealer.

Handling the power cord

When unplugging from the wall socket, always pull the plug body, never the power cable.

Volume settings

A CD player has almost zero background noise. Because of this, the technique of listening to the background level and then setting the volume before the music starts, as used with analog turntables or tape decks, cannot be used. If you raise the volume level too high, speaker damage may result.

Condensation

The CD player uses optical components. If it is moved from a cold location to a warm one, or is used in a room subject to excessive humidity or where a fire has just been lit, condensation could form on the optical components.

This may prevent the laser beam from being properly transmitted and thus causes noise or even a malfunction.

If condensation has formed and the CD player does not function correctly, we recommend that you leave it turned on for an hour or two. If at the end of this time the CD player still does not function properly, please consult your JVC dealer.

Transporting the unit

When carrying this unit, it is best to avoid either tilting or turning it upside-down. When you cannot avoid doing so, please remove the discs first.

Using compact discs

Compact discs are made of plastic and can easily be damaged. If the disc is dirty, scratched, warped or otherwise damaged, the digital information may not be picked up correctly.

Applicable discs

This unit can only be used with compact discs bearing the marks below. Never use discs of other types.



CD-R and CD-RW discs recorded with the Audio CD format can be played back, though some may not be played back because of the disc characteristics or recording condition.

NOTE

- CD-R and CD-RW discs must be finalized.

About this manual

This manual covers the operating instructions for the compact disc automatic changer XL-FZ700BK.

This manual is organized as follows:

The first part, "Introduction", gives you the precautions when using this unit, and shows you the names of buttons on the main unit and the remote control unit.

The second part, "Before using for the first time", tells you what kind of operations you should do before playing discs. This part describes where to place the unit for best results, how to install batteries in the remote control unit and how to connect this unit to the amplifier/receiver and other components.

The third part, "Basic operations", describes how to load discs, and convenient basic functions for playing discs.

The fourth part, "Various playback patterns", describes various functions for playing discs.

The fifth part, "General informations", describes the COMPU LINK remote control system which facilitates various operations between JVC components, and explains how to take care of discs.

This part also includes "Troubleshooting", which tells you how to check the unit when a malfunction occurs, and the technical informations regarding this unit.

Names of buttons

Main unit

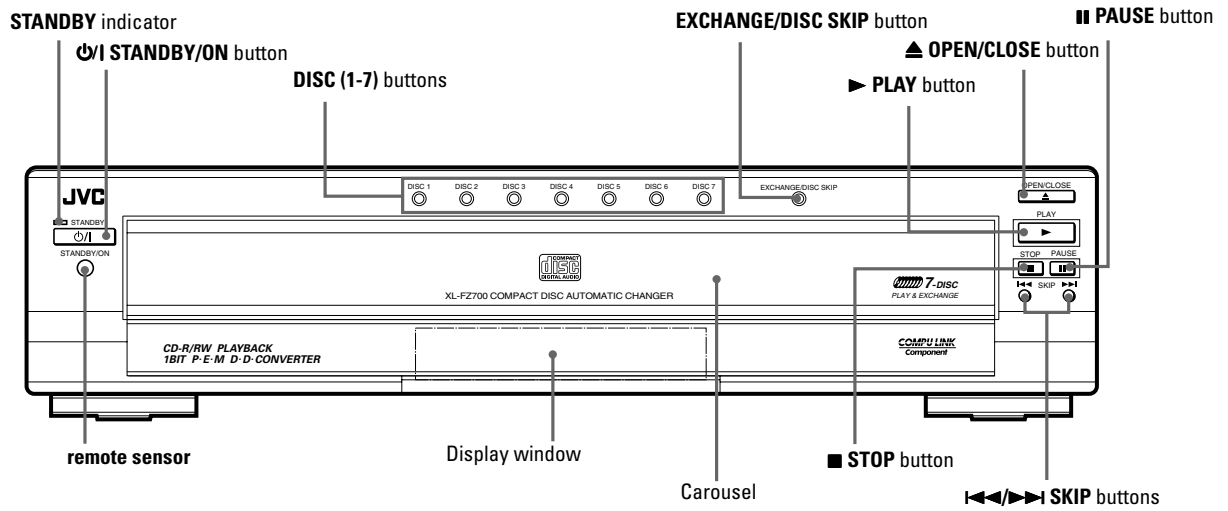

DIGITAL OUT OPTICAL jack

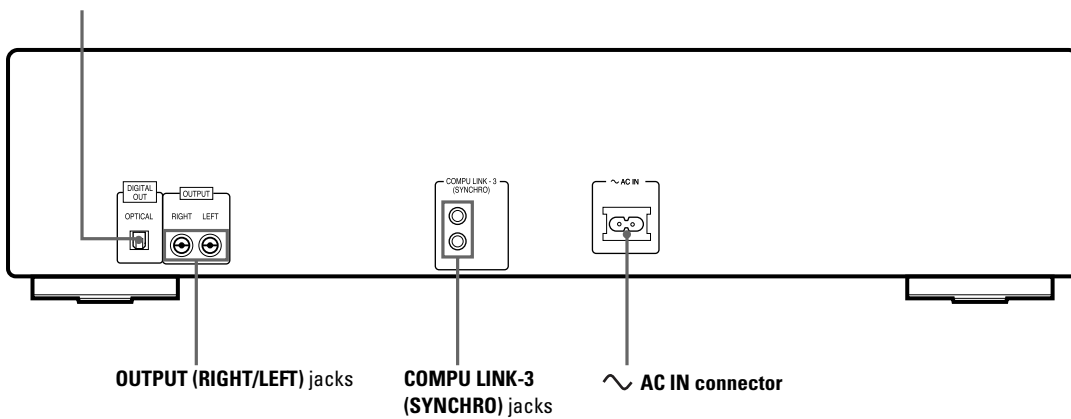

Remote control unit

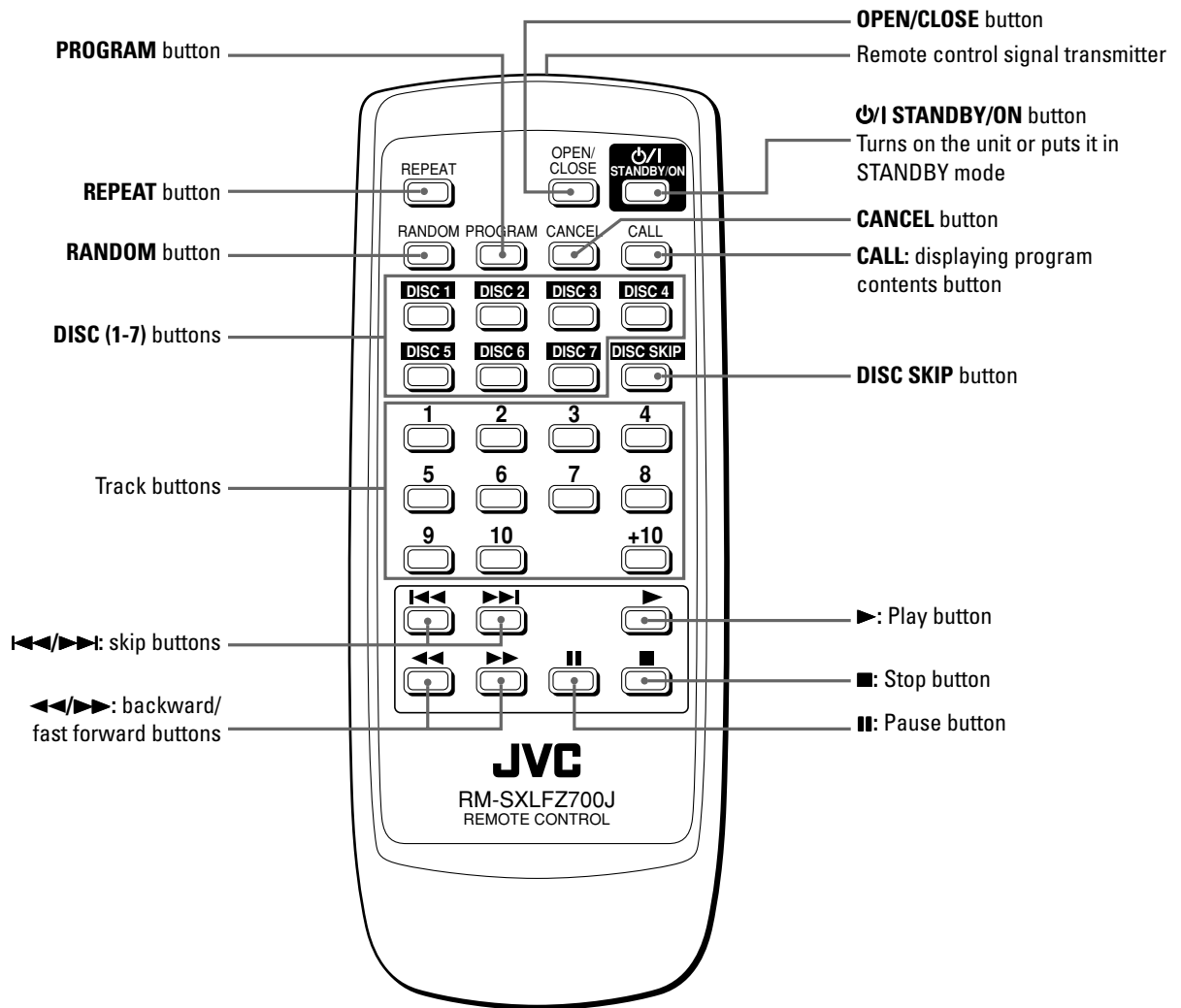

Display window

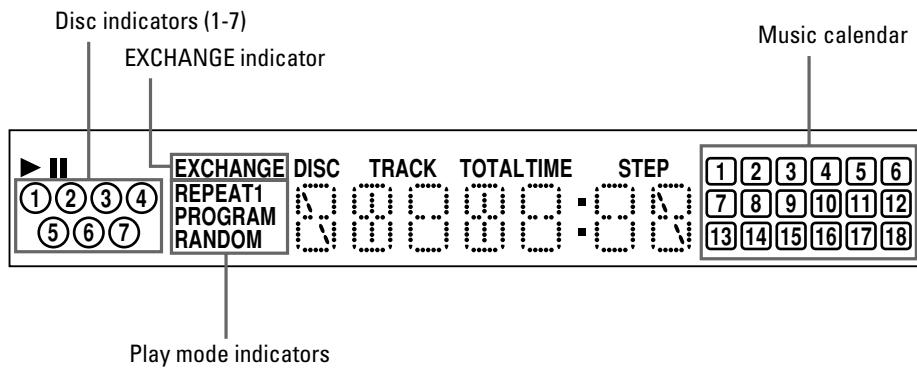

Installing the unit

Best location

Select a location which is level, dry and neither too cold nor too hot (temperature range 5°C to 35°C). Also, avoid dusty locations or any location subject to vibration.

If interference occurs

If this unit is placed near a tuner or a radio receiver tuned to AM frequencies, interference may occur. If this happens, we recommend either that you move this unit as far as possible from the tuner or receiver or briefly turn off the power of this unit.

Connecting to the Analog Output Jacks

Connecting to an amplifier or receiver allows you to listen to the sound from the speakers. Connect the OUTPUT jacks of this unit to the line input jacks of an amplifier or receiver with the supplied audio cord.

NOTES

- Never connect the OUTPUT jacks to the PHONO jacks of the amplifier or receiver. This may cause damage to the components.
- Make sure that the same channels are connected between this unit and the amplifier or receiver: LEFT to LEFT and RIGHT to RIGHT.
- Do not connect the power plug until all connections are complete.
- Connect the plugs firmly. Loose connections may cause noise or malfunction.

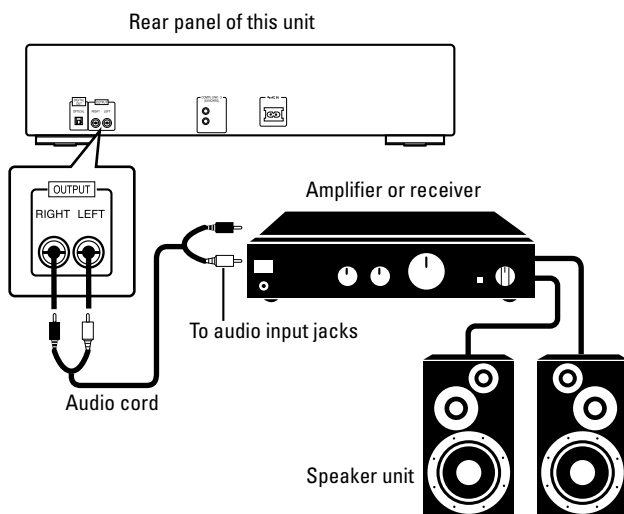

Connecting to the Digital Output Jack

It is possible to transmit a digital sound signal from this unit directly to a MD recorder, etc.

NOTES

- Never connect the digital output cable except to the digital input jack.
- An optical digital cord (optional) is required to make this connection. Refer to the instruction manual of the MD recorder, etc. for details.

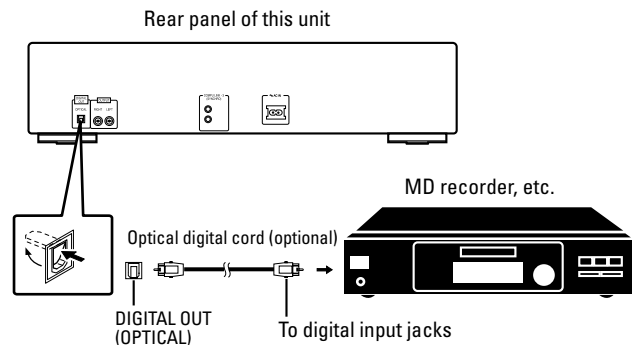

Supplying the power

To connect the AC power cord of the main unit

The AC power cord is supplied separately and must be connected to the unit. Plug the AC power cord into the ~ AC IN connector of this unit and connect to the wall outlet after all connections are complete.

NOTE

- When using the COMPU LINK Remote Control System (see page 6), do not connect the power cord to the SWITCHED AC OUTLET of an amplifier or receiver.

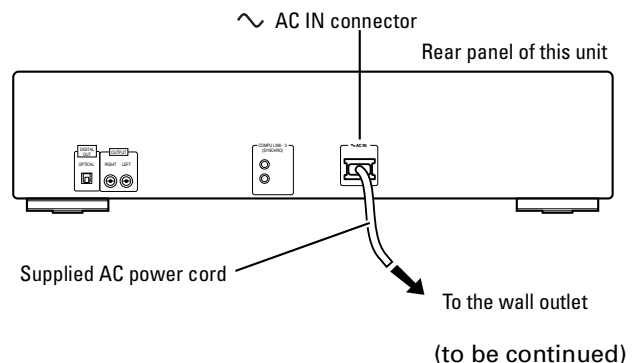

To install the batteries in the remote control unit

Before operating the remote control unit, install two batteries.

- 1 While pushing the tab of the rear cover, remove the rear cover from the remote control upwardly.

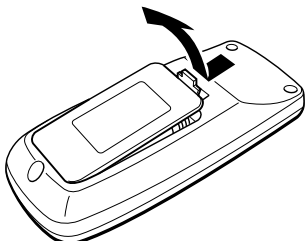

- 2 Install batteries. Be sure that the batteries are installed with correct polarity, (+) and (-).

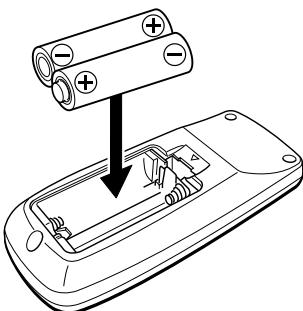

- 3 While aligning the end of the rear cover with the remote control, assemble the rear cover on the remote control by pushing it downwardly.

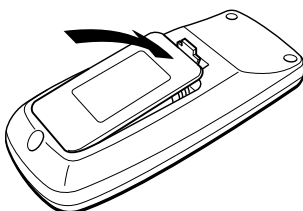

NOTES

Incorrect use of batteries can cause corrosion or damage. Note the following points to lengthen battery life.

- Install batteries observing the correct polarity, (+) and (-).
- Do not use new and old batteries simultaneously.
- Batteries with similar shapes may have different voltage ratings. Be sure to use the correct batteries.
- Remove batteries from the remote control unit if it will not be used for a long period of time.
- Do not expose batteries to heat or flame.

Battery replacement

Service life of batteries depends on the condition of use; standard life is about one year. When the batteries become weak, the operating distance of the remote control unit becomes short. If this happens, replace the batteries R6P(SUM-3)/AA(15F) with new ones.

NOTE

- The lower the temperature, the shorter the battery life.

COMPU LINK connection

JVC's COMPU LINK Remote Control System provides unified control over system components connected with COMPU LINK. Connecting JVC audio components with the COMPU LINK jacks automatically controls relative operations between components and facilitates various operations. With the COMPU LINK connection to an amplifier or receiver, you can operate XL-FZ700BK with the amplifier or receiver's remote control unit. Synchronized recording is also available with this feature.

Connecting the COMPU LINK cord

The COMPU LINK-3 (SYNCHRO) jacks are used to output and input the control signal for the COMPU LINK remote control system.

COMPU LINK-compatible products are provided with the jacks marked COMPU LINK-1, COMPU LINK-2 or COMPU LINK-3, referring to the COMPU LINK version. XL-FZ700BK is equipped with COMPU LINK-3. You can connect XL-FZ700BK also to a component with lower COMPU LINK versions. But, in that case, only the lower versions' features will be available.

Plug the supplied COMPU LINK cord into the COMPU LINK-3 (SYNCHRO) jack on the rear panel of XL-FZ700BK. Plug the other end into the COMPU LINK jack of the other component. If there are two COMPU LINK jacks, plug it into either of them.

Connect to the COMPU LINK-3 (SYNCHRO) jack of another component equipped with the Compu Link remote control system.

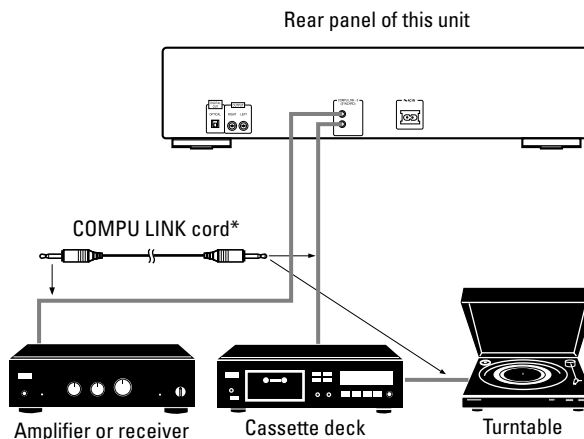

* Only one COMPU LINK cord is supplied.

Basic functions for disc playback

Turning on the power of this unit

Press the  STANDBY/ON button to turn on this unit. The STANDBY indicator is turned off and the display is turned on.

Main unit

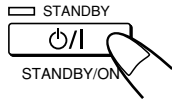



Remote control unit



Press again to turn off the power and activate the standby mode. The STANDBY indicator is lit and the display goes out.

The power is automatically turned on also by;

- Pressing the  OPEN/CLOSE button on the main unit or the OPEN/CLOSE button on the remote control unit. The carousel will be opened.
- Pressing the  PLAY button on the main unit or the  button on the remote control unit. The disc that was lastly selected will be played back. If no disc is set in all the disc trays, "NO DISC" will appear.
- Pressing the DISC (1-7) button on the main unit or the remote control unit. The corresponding disc will be played back.

NOTES

- A small amount of power (3.0 W) is consumed even in the standby mode.
- To turn off the power completely, disconnect the power cord from the wall outlet.

Remote control operation

Point the remote control unit towards the remote sensor and operate it steadily and carefully. The remote control unit can be used within a range of about 7 m from the remote sensor, and at angles of up to about 30 degrees.

Inserting and removing discs

Up to 7 discs can be set on the disc tray carousel.

- 1 Open the carousel by pressing the  OPEN/CLOSE button on the main unit or the OPEN/CLOSE button on the remote control unit.

You can access to two of seven trays.

Main unit

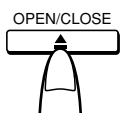

Remote control unit

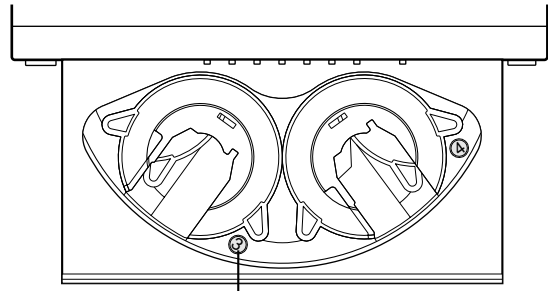

The number written on the carousel corresponds to the disc number shown on the display

NOTE

- From the second time on, the carousel opens with the previously played disc on the left-front tray.

- 2 Press the EXCHANGE/DISC SKIP button on the main unit or the DISC SKIP button on the remote control unit to select accessible disc trays if required.

Main unit



Remote control unit



Each time the button is pressed, the carousel rotates clockwise by an amount for accessing the next two disc trays.

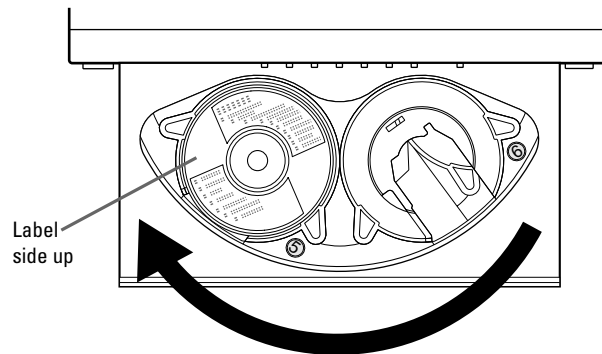

- 3 Place one or two discs in the disc tray(s) with the label side up.

- To insert an 8-cm disc, place it in the inner recess.

CAUTION

When loading discs in the disc tray, be sure to put the discs according to the recess. Otherwise, the discs will be damaged when the carousel is closed, and cannot be removed from the unit.

- 4 Repeat steps 2 and 3 to set more discs onto other disc trays.

- 5 Press the  OPEN/CLOSE button on the main unit or the OPEN/CLOSE button on the remote control unit to close the carousel.

Disc to be played back

The disc set in the front-left disc tray when the carousel closes is loaded for playback. If no disc is set in the front-left disc tray when the carousel closed, the unit rotates the carousel clockwise until it finds a disc. If no disc is set at all in the carousel, "NO DISC" will appear on the display.

Playback operation before closing the carousel

- By pressing the ► PLAY button on the main unit or the ► button on the remote control unit, the carousel closes and the disc to be played back firstly will be played back.
- By pressing the DISC (1-7) buttons on the main unit or the remote control unit, the specified disc will be played back.

To stop playback temporarily

Press the || PAUSE button on the main unit or the || button on the remote control unit. The || indicator lights on the display and playback stops temporarily. To resume playback, press the ► PLAY button on the main unit or the ► button on the remote control unit again.

Stopping playback

Press the ■ STOP button on the main unit or the ■ button on the remote control unit.

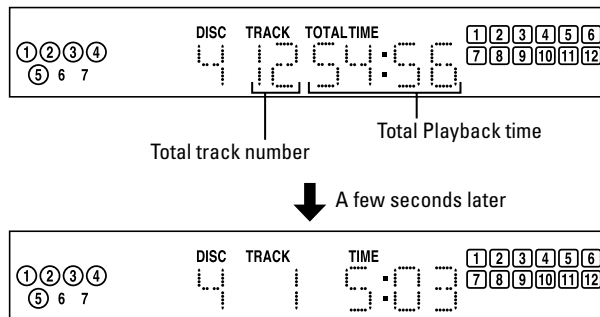
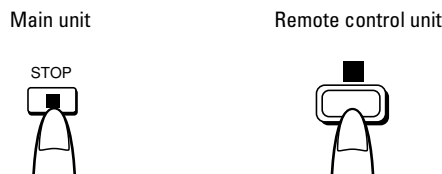

Playing a disc

Playing a disc

Press the ► PLAY button on the main unit or the ► button on the remote control unit. The ► indicator lights on the display and playback starts.

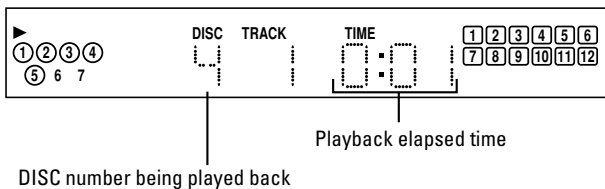
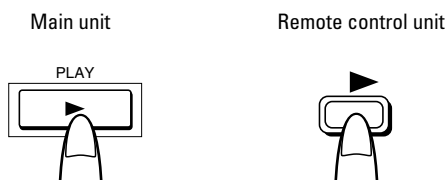

NOTE

- All available discs are sequentially played back. Playback will continue until you stop it. (See "Stopping playback" on this page.)

Playing a desired disc

Press a desired DISC (1-7) button. The ► indicator lights on the display and playback starts.

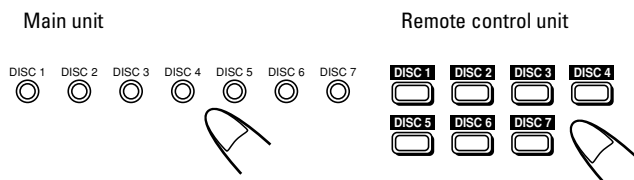

- The DISC (1-7) button without the circle in the DISC indicator does not work.

About the DISC (1-7) indicators

- Each DISC indicator shows the current status of the corresponding tray as follows:
- The circle of the DISC indicator will light if a disc is set in the corresponding disc tray. (The numbers 1-7 are always lit.)
 - The circle is unlit if no disc is set in the corresponding disc tray.

NOTES

- Inserted disc is detected when the carousel is turned. So, until then, the unit cannot know the disc presence status of the disc tray. For such disc trays, the unit temporarily turns on the corresponding indicators.
- During program play mode, the number shows the presence of disc and the circle shows the disc being programmed.
- During random play mode, the number shows the presence of disc and the circle shows the disc being played back for random play.

About the music calendar

When a disc to be played back is read, the contents (track numbers) of the disc appear on the music calendar. As the track is finished to play back or skipped, the track number will disappear from the music calendar.

NOTE

- During program play mode, only the programmed tracks appear on the music calendar.

Locating a point to start playback

Skipping to a desired disc during playback (DISC SKIP)

Use the DISC SKIP button on the remote control unit.

Remote control unit



Each time the DISC SKIP button is pressed, the selected DISC number changes from 1 to 7, then back to 1. The selected disc will be played back.

- You can also use this button during stop mode.

NOTE

- The EXCHANGE/DISC SKIP button on the main unit does not work for this purpose.

Changing to a desired disc during playback DISC (1-7)

Press any DISC (1-7) button to select a desired disc.

Main unit

Remote control unit

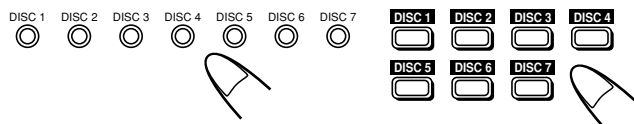

The selected disc will be played back.

- You can also use these buttons during stop mode.

Skipping to a desired track during playback

Using the <<</>>> buttons

Main unit

Remote control unit



To skip back to the beginning of the track being played, tap the <<< button. When the beginning of the track is reached, tapping this button again skips to the previous track.

To skip to the next track, tap the >>> button.

- You can also use these buttons during stop mode.

Using the track buttons

Remote control unit

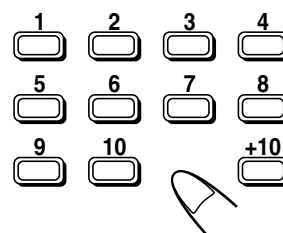

To skip to the desired track during playback, press the corresponding track buttons.

[How to use the track buttons]

When selecting track number 11 or above, use the [+10] button.

Example:

To select track number 12, press [+10] and then [2].

To select track number 25, press [+10] twice and then [5].

To select track number 30, press [+10] twice and then [10].

Searching for a desired section

During playback, press and hold the <<</>>> SKIP buttons on the main unit or the <<</>>> buttons on the remote control unit.

Main unit

Remote control unit



Playback advances or reverses rapidly.

While the <<< button on the main unit or the <<< button on the remote control unit is kept pressed, playback rapidly reverses toward the beginning of the track. While the >>> button on the main unit or the >>> button on the remote control unit is kept pressed, playback rapidly advances toward the end of the track. When the desired section is reached, release the button. The player resumes normal playback from that point.

- While searching, you can hear a playback sound.

Specifying a desired track in stop mode

To specify the desired track number, use the track buttons (1-10, +10).

Remote control unit

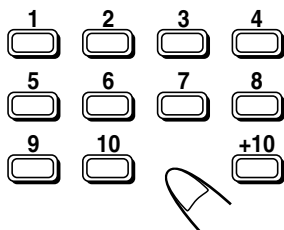

The unit searches for the selected track and playback starts automatically.

To specify the track number with the track buttons, see "How to use the track buttons" on page 9.

Playing tracks in a order of disc/track number

You can continuously play all the loaded discs, starting from any track on any disc.

- 1 Press the ► PLAY button on the main unit or the ► button on the remote control unit to start playback.

Playback starts from the current disc. The following display appears.

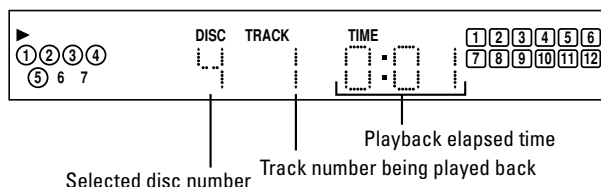

- 2 Use the DISC (1-7) buttons on the main unit or the remote control unit to select the disc number which contains the first track you want to play.

When you want to play from the first track on the selected disc, it is not necessary to select the track number. In this case, omit the next step.

- 3 Select the track number with the ◀◀/▶▶ buttons on the main unit or the remote control unit or the track buttons on the remote control unit.

The selected track number appears on the display and playback starts from the selected track automatically.

To select the track number with the track buttons, see "How to use the track buttons" on page 9.

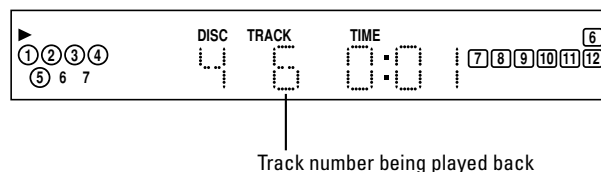

Changing discs during playback (EXCHANGE)

During playback of a disc, you can change other discs in the disc trays without stopping playback.

Press the EXCHANGE/DISC SKIP button on the main unit. The carousel opens and you can change the discs inside. The EXCHANGE indicator lights on the display.

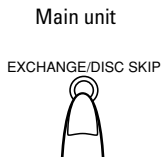

To change the discs loaded in the far end of the disc tray, press the EXCHANGE/DISC SKIP button on the main unit or the DISC SKIP button on the remote control unit to make the carousel rotate. After changing the discs, press the ▲ OPEN/CLOSE button to close the carousel. Then, the EXCHANGE indicator goes out on the display.

It is also possible to change the discs during program playback or random playback, following the above procedure.

NOTE

- When the carousel is opened by pressing the EXCHANGE/DISC SKIP button on the main unit, it is not possible to close it by pushing it back with hand. Always press the ▲ OPEN/CLOSE button to close the carousel.

Playing tracks in a desired order (Program Play)

You can play only the favorite tracks in any desired order.

- 1 In stop mode, press the PROGRAM button so that the PROGRAM indicator lights on the display.

Remote control unit



- 2 Select the disc which contains the track to be programmed with the DISC (1-7) button. "AL" (all tracks) appears on the display.

ex.) When disc 4 is selected.

Shows that a disc is loaded

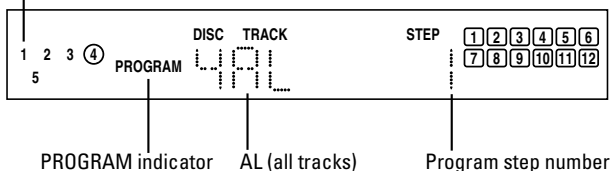

To program the entire disc

When the track number is not specified after selecting the disc number, all tracks on the selected disc are programmed.

- 3 Select the track number by pressing the track buttons on the remote control unit.

To select the track number with the track buttons, see "How to use the track buttons" on page 9.

Remote control unit

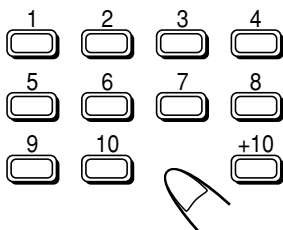

ex.) When track 5 is selected.

Shows the disc being programmed

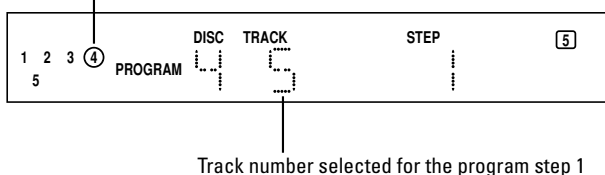

Track number selected for the program step 1

- If you want to cancel the displayed program step, press the CANCEL button on the remote control unit and then enter a new disc number and/or track number.

- 4 Repeat steps 2 and 3 for other tracks and/or discs to be programmed.

You can program up to 32 steps.

- 5 Start playback by pressing the ► PLAY button on the main unit or the ► button on the remote control unit.

The programmed tracks and/or discs are played in the programmed order and, when all the programmed tracks/discs are played back, program playback stops.

- You can skip to a desired program step with the ◀◀/▶▶ buttons.

If you have programmed all discs as "AL", pressing ▶▶ (or ◀◀) will skip to the next (or previous) disc.

- **To check the program contents**

In stop mode or during playback, press the CALL button on the remote control unit. Each time the CALL button is pressed, the program contents are displayed in the programmed order. (After pressing the CALL button, perform the next button operation within five seconds (during the program step number is blinking).)

- **To modify the program contents in stop mode**

To add a new program step to the last step, enter the new disc number and/or track number referring to steps 2 and 3 above.

To delete the program step from the last step, press the CANCEL button on the remote control unit. Each time the CANCEL button is pressed, the last program step is deleted one by one.

To delete any program step, press the CALL button to locate the program step number you want to delete, and then press the CANCEL button. (After pressing the CALL button, perform the next button operation within five seconds (during the program step number is blinking).)

- **To exit program mode in stop mode**

To exit program mode, press the PROGRAM button on the remote control unit so that the PROGRAM indicator goes out on the display. However, the program contents are not erased and, whenever the program mode is selected, you can play the tracks in programmed order.

- **To clear the entire program contents**

In stop mode, press the CANCEL button on the remote control unit repeatedly until entire program contents are deleted. Or, press the ▲ OPEN/CLOSE button on the main unit or the OPEN/CLOSE button on the remote control unit.

Even after the entire program contents have been cleared, the unit remains in program mode.

Note that turning off the unit does not clear the program contents.

If the AC power cord is disconnected from the outlet, the program will be erased.

Playing tracks in a random order (Random Play)

You can select and play tracks in random order from all the discs loaded in the unit. Selections are made so that each track is played only once.

- 1 In stop mode, press the RANDOM button so that the RANDOM indicator lights on the display.

Remote control unit

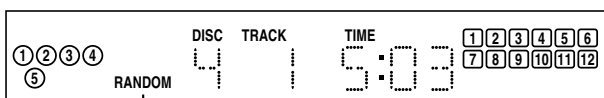

RANDOM indicator

- 2 Press the ► PLAY button on the main unit or the ► button on the remote control unit to start playback.

- To skip to the track to be played next, press the ►► button.
- To skip to the beginning of the current track, press the ◀◀ button.

• **To cancel random playback**

In stop mode, press the RANDOM button on the remote control unit. The RANDOM indicator goes out and the random playback is cancelled.

Playing repeatedly (Repeat Play)

Normally, all available discs are sequentially played back. However, with the repeat play function, you can repeatedly play all tracks of a disc or one track. It is also possible to utilize this function in combination with random/program playback function.

Repeating all the tracks of a disc

Press the REPEAT button repeatedly until the REPEAT indicator lights on the display.

Remote control unit

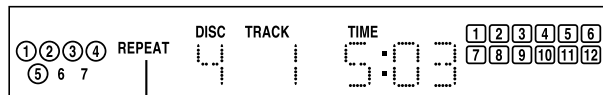
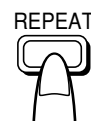

REPEAT indicator

When playback starts, all tracks of the disc being selected will be played repeatedly. (To select a desired disc, see "Playing a desired disc" on page 8.)

- You can use this function together with the program playback or random playback. In program mode, the programmed contents are played repeatedly. In random mode, all the tracks are played repeatedly in random order.

Repeating one track

Press the REPEAT button repeatedly until the REPEAT 1 indicator lights on the display.

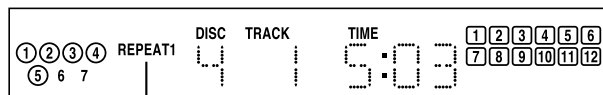

REPEAT1 indicator

When playback starts, the track being selected will be played repeatedly. (To select a desired track, see "Skipping to a desired track during playback" on page 9.)

- You can use this function together with the program playback or random playback.

To cancel repeat mode

Press the REPEAT button so that both the REPEAT and REPEAT 1 indicators go out.

Various playback patterns

COMPU LINK remote control system

The COMPU LINK Remote Control System controls relative operations between components automatically and facilitates various operations.

This is a system originated and developed by JVC for facilitating various system operations. The following is a brief explanation of this system:

Automatic source selection

When the supplied COMPU LINK cord is utilized to connect this unit to others equipped with COMPU LINK jacks, switching-in of each system component can be performed with a single touch on the source selector button located on a JVC amplifier or receiver.

When selection is carried out in this manner, the corresponding unit will automatically start operation.

Upon pressing of the play button, the source selector of the amplifier or receiver changes automatically. When a new unit is switched in, the previously selected component stops operation within five seconds.

Synchronized recording

Synchronized recording refers to the process in which a JVC cassette deck starts recording, synchronized with this unit. Synchronized recording is carried out as follows:

- 1 Set the cassette deck to the recording pause mode in accordance with its instructions.
- 2 To record only certain tracks or discs, program the tracks in any order, as desired.
- 3 Press the ► PLAY button on the front panel of this unit. The cassette deck automatically starts recording, synchronized with this unit.

NOTES

- Synchronized recording stops automatically when this unit stops playback.
- To cancel synchronized recording, press the stop button of this unit or the cassette deck.
- To properly operate the synchronized recording, the buttons/controls other than ⏻/STANDBY/ON, ■ STOP and ▲ OPEN/CLOSE buttons do not function.
- If the recording pause mode is set on the cassette deck by pressing the || PAUSE button after pressing the ● REC and ► PLAY buttons simultaneously, synchronized recording is not possible. For details, refer to the instructions for the cassette deck.

Automatic power on/off function

This function is to control the power on/off of the receiver/amplifier or this unit respectively as the following.

- When this unit enters playback mode, the power of the receiver or amplifier is turned on.
- When the source selector of the receiver/amplifier is set to CD function mode, the power of this unit is turned on.

NOTES

- Abnormal operation may result if the power supply of the component(s) is interrupted. If this happens, you must start over again.
- Ensure that the COMPU LINK jacks of the each component are connected with the supplied COMPU LINK cord. Also, be sure to fully read the instructions for each component.
- When the power of the amplifier or receiver is switched off, this unit is also turned off automatically.

Care and handling

How to handle CDs

When handling compact discs, do not touch the surface of the disc (reflective silver side — the side without the label). Since compact discs are made of plastic, they are easily damaged. If the disc gets dirty, dusty, scratched or warped, the sound will not be picked up correctly and, in addition, such discs may cause the CD player to malfunction.

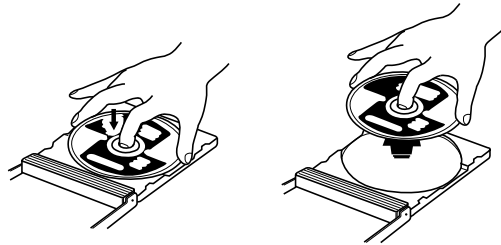

Even on label side

Do not damage the label side, stick paper to or use any adhesive on the surface.

Storage

Make sure that discs are kept in their cases. If discs are piled one on top of another without their protective cases, they can be damaged.

Do not put discs in any location where they can be exposed to direct sunlight, or in any place where humidity or temperature is high. Avoid leaving discs in your car!

Maintenance of discs

When there are fingerprints or other dirt adhering to a disc, wipe the disc with a soft, dry cloth with a movement going from the center outwards.

If difficult to clean, wipe the disc with a cloth moistened with water.

Never use record cleaners, petrol, alcohol or any anti-static agents.

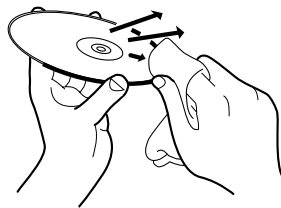

Troubleshooting

What appears to be a malfunction may not always be serious. Please go through the following list before requesting service.

Symptom	Possible case	Remedy
The unit is not operative.	Power plug is disconnected from the AC outlet.	Connect the plug to the AC outlet.
	Discs are not loaded.	Load discs in the disc tray.
Playback is not possible.	Disc is inserted upside down.	Load the disc with its label-side up in the disc tray.
	Disc is not loaded in the correct position.	Load the disc according to the groove of the disc tray.
	Moisture is condensed inside the unit.	Leave the unit turned on until the moisture evaporates.
	Disc is not finalized.	Finalize the disc.
The reproduced sound includes noise.	Disc is dirty.	Wipe off the disc surface with a soft cloth.
	Disc is warped.	Replace the disc with a new one.
The sound is intermittent.	Disc is scratched.	Replace the disc with a new one.
The remote control unit does not function.	Batteries are exhausted.	Replace both batteries.
	There is an obstacle between remote control unit and the remote sensor of the main unit.	Remove the obstacle.
	Direct sunlight shines on the remote sensor of the main unit.	Shade the unit from the direct sunlight.

Specifications

General

Format:	Compact disc digital audio
Signal detection system:	Non-contact optical detection
CD capacity:	7 discs
Sampling frequency:	44.1 kHz
Power requirements:	AC 110 V – 240 V \sim , 50/60 Hz
Power consumption:	9.0 W (POWER ON) 3.0 W (STANDBY mode)
Dimensions (W x H x D):	435 mm x 102 mm x 448 mm
Mass:	Approx. 5.5 kg

Audio performance

Frequency response:	2 Hz to 20 000 Hz (\pm 1 dB)
Dynamic range:	98.0 dB (at 1 kHz)
Signal to noise ratio:	108.0 dB
Total harmonic distortion:	0.002% (at 1 kHz)
Wow and flutter:	Less than measurable limit
Output level:	2.0 Vrms

Accessories

AC power cord (1)
AC plug adaptor (1)
Audio cord (1)
COMPU LINK cord (1)
Remote control unit (RM-SXLFZ700J) (1)
Batteries R6P(SUM-3)/AA(15F) (2)

* Designs and specifications are subject to change without notice.

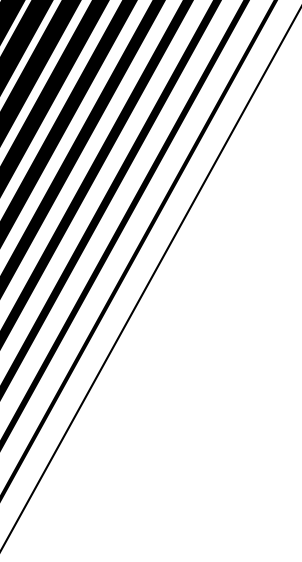

JVC
VICTOR COMPANY OF JAPAN, LIMITED